



Contents

- ◆ **PREPARATION**
 - Safety Precautions 3
 - Name of Each Part 8
 - Remote Control – Buttons and Display 10
 - Inserting the Remote Control Batteries 11
 - Getting Started 12
- ◆ **OPERATION**
 - Selecting Auto Mode 13
 - Selecting Cool Mode 14
 - Selecting Heat Mode 15
 - Selecting Dry Mode 16
 - Selecting Fan Mode 17
 - Selecting **good' sleep** Mode 18
 - Selecting the Turbo Function 20
 - Adjusting the Airflow Direction Vertically 21
 - Adjusting the Airflow Direction Horizontally 21
 - Setting the On Timer 22
 - Setting the Off Timer 23
 - Operating Your Air Conditioner Without the Remote Control 24
- ◆ **RECOMMENDATIONS FOR USE**
 - Cleaning Your Air Conditioner 25
 - Cleaning Deodorizing and Bio filter(Optional) 25
 - Temperature and Humidity Ranges 26
 - Operating Recommendations 26
 - Solving Common Problems 27



Correct Disposal of This Product (Waste Electrical & Electronic Equipment)

(Applicable in the European Union and other European countries with separate collection systems)

This marking shown on the product or its literature, indicates that it should not be disposed with other household waste at the end of its working life. To prevent possible harm to the environment or human health from uncontrolled waste disposal, please separate this from other types of waste and recycle it responsibly to promote the sustainable reuse of material resources.

Household users should contact either the retailer where they purchased this product, or their local government office, for details of where and how they can take this item for environmentally safe recycling.

Business users should contact their supplier and check the terms and conditions of the purchase contract. This product should not be mixed with other commercial waste for disposal.



Safety Precautions

The following safety precautions are provided to protect the users' safety and prevent property damage. Make sure to read the followings and use the air conditioner properly.

► Keep this user's manual together with the installation manual in a handy place so that you can find it whenever you need to see it after reading this manual thoroughly.

 **WARNING** • This indicates the possibility of serious injury or death.

 **CAUTION** • This indicates the possibility of serious injury or damage to environments when operated incorrectly.

WHEN INSTALLING



► Do not install the unit in a place where it is exposed to inflammable gas leakage.

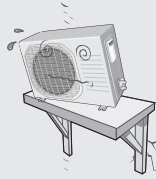

► Do not install the outdoor unit where there's the risk of dropping such as on high outer wall or outside of the terrace.

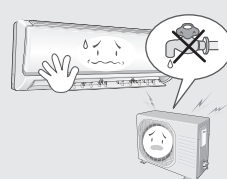

► Do not connect the ground to a gas pipe, water pipe, lightning rod or telephone earth.



► Contact the service center if the air conditioner is under water.



► The installation must be carried out by a licensed installer or qualified personnel when installing the unit for the first time or reinstalling it.

REGARDING POWER SOURCE



► Do not pull the electric wire or touch the power plug with the wet hands.



► Install the switch and circuit breaker only for air conditioner.

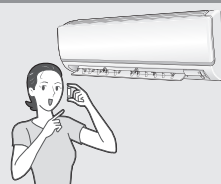

► Use the rated current fuse.



► Do not bend the electric wire by force or weigh down the air conditioner not to be out of order.



► Use the power source with separate wiring only for air conditioner.



► If the power plug is damaged, replace it by the manufacturer or qualified personnel to avoid the risk.

WARNING

DURING OPERATION



- ▶ Do not attempt to repair, move, modify or reinstall the unit on your own. Make sure that these installations are carried out by qualified personnel to avoid electric shock or fire.

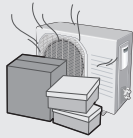

- ▶ Do not place any obstacles in front of the unit. Make sure that the unit is correctly ventilated at all times: Do not place clothing or other materials over it.

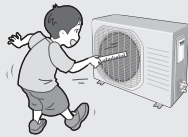

- ▶ Do not insert anything between the air outlet blades because the inner fan may be damaged and could cause injury. Keep children away from the unit.

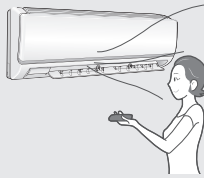

- ▶ When using a wireless remote control, the distance should not be more than 7 meters from the air conditioner. (If applicable)

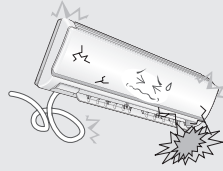

- ▶ The manufacturer declines any liability for damage resulting from modifications or errors in the electrical or hydraulic connections.

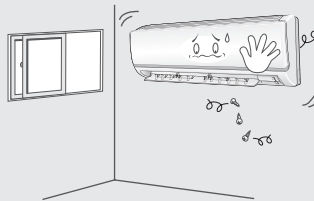

- ▶ Failure to observe the installation instruction, or use of the unit under conditions other than those indicated in the table 'Operating limit' of the unit installation manual, will immediately invalidate the unit warranty.



- ▶ Never spill any kind of liquid into the unit. Should this happen, unplug or main switch off the unit and contact an authorized service center.

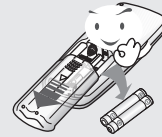

- ▶ If the wireless remote control is not used for a long time, remove the batteries. (If applicable)

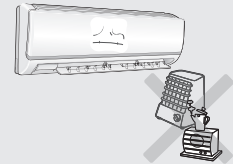

- ▶ Do not connect the electric heater to the air conditioner or repair it with your discretion.



- ▶ Do not place any materials so that children cannot step on it.



WARNING

DISPOSING THE UNIT

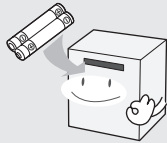

- ▶ Before throwing out the device, it is necessary to pull back the battery cells and get rid of them safely for recycling reasons.

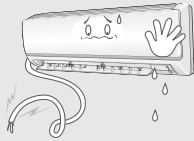

- ▶ When you need to dispose of the unit, consult your dealer. If pipes are removed incorrectly, refrigerant may blow out and come into contact with your skin, causing injury. Releasing refrigerant into the atmosphere also damages the environments.



- ▶ Please recycle or dispose of the packaging material for this product in an environmentally responsible manner.



CAUTION

WHEN INSTALLING

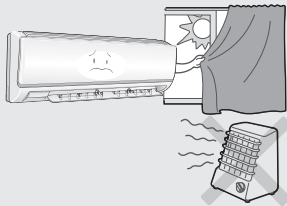

- ▶ Install the air conditioner avoiding direct sunlight or heater, especially water.

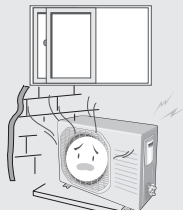

- ▶ Install the outdoor unit so as to let the discharged air out properly. Avoid a place that may disturb your neighbor by noise.

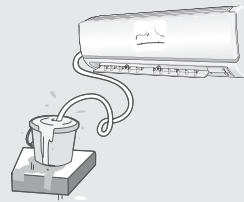

- ▶ Install the drain hose to let the water run safely and correctly.



CAUTION

REGARDING POWER SOURCE



- ▶ Disconnect the circuit breaker when you don't use the air conditioner for a long time to save energy.



- ▶ Contact the service center or manufacturer if you want to repair the air conditioner.



- ▶ Contact the service center after turning off the air conditioner if strange noise is heard, burning smell or smoke blow.

DURING OPERATION

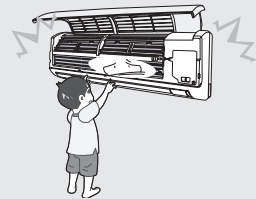

- ▶ Do not open the front grille during operation.



- ▶ Do not use the air conditioner for a long time in a closed room or in a place where there's a baby or an old person.

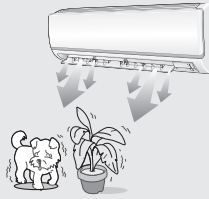

- ▶ Avoid cold and hot air reaching to person, pet or a plant directly for a long time.



- ▶ Do not step on the air conditioner or put heavy object on it.



- ▶ Avoid the water from getting into the air conditioner.

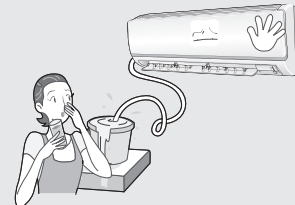

- ▶ Do not drink the water from the air conditioner.



CAUTION

DURING OPERATION

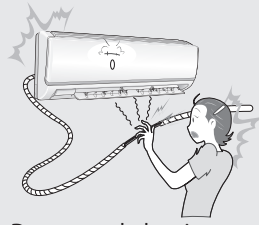

▶ Do not touch the pipes connected to the air conditioner.



▶ Do not use the air conditioner to maintain the machine, food, pet, plant or cosmetics.



▶ Do not give excessive shock to the air conditioner.

OTHERS

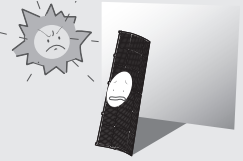

▶ Be sure that the air filter not to be exposed to direct sunlight.



▶ Turn off the air conditioner and if the fan stops to operate, clean the air conditioner.



▶ Clean the air filter every 2 weeks.



▶ Be sure to insert the air filter.

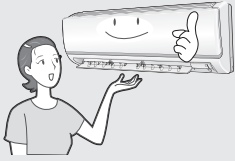

▶ The appliance is not intended for use by young children or infirm persons without supervision: Young children should be supervised to ensure that they do not play with the appliance.



▶ Do not clean the air conditioner by spraying water directly or with benzene, thinner or alcohol.

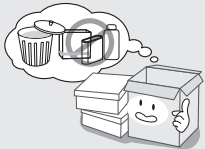

▶ Dispose of the packaging material in accordance with the local requirements.



▶ The maximum input power & current is measured according to the IEC standard and the input power & current is measured according to the ISO standard.



▶ The surface of the heat exchanger is sharp, so be careful of it when cleaning.

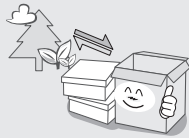

▶ All of the manufacturing and packaging materials used for your new appliance are compatible with the environment and can be recycled.





Name of Each Part

The design and shape can be changed according to the model.

Indoor Unit

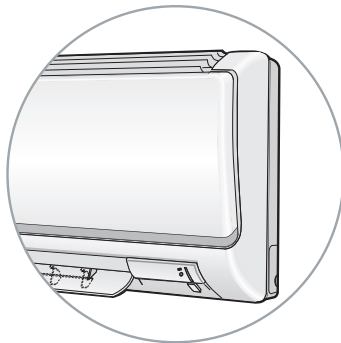
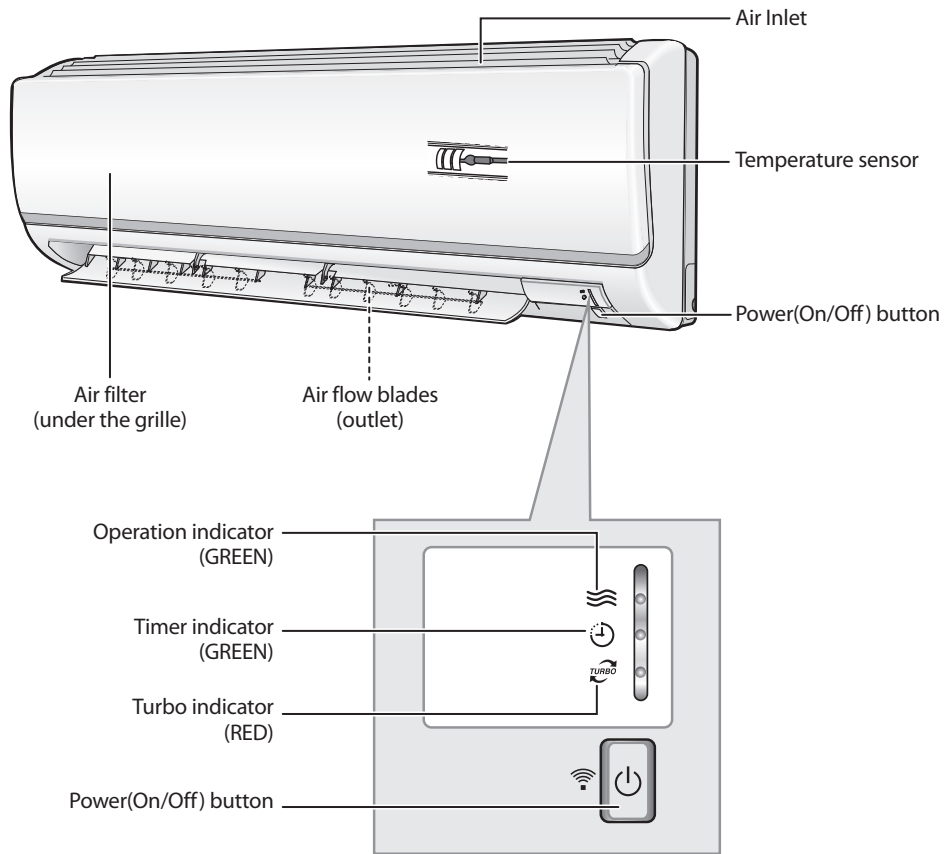

AQN** Series**

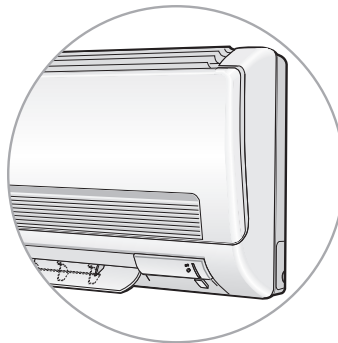

AQF** Series**



AQ09S Series**





Outdoor Unit

AQ09*** Series

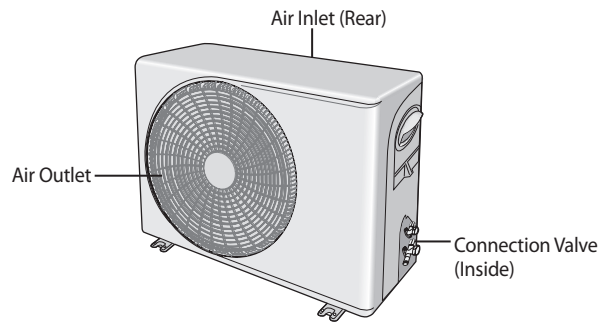

Outdoor Unit

AQ12*** Series

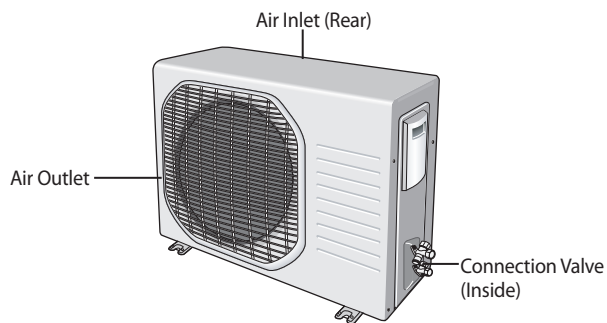

Outdoor Unit

AQ18*** Series

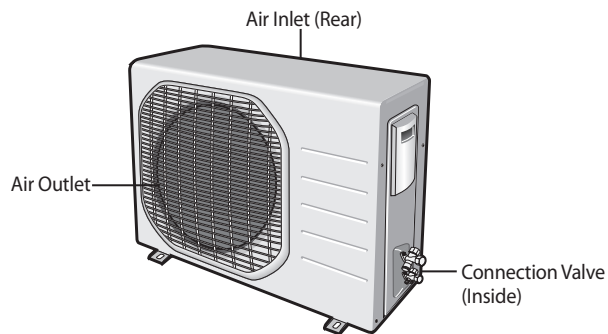

Outdoor Unit

AQ24*** Series

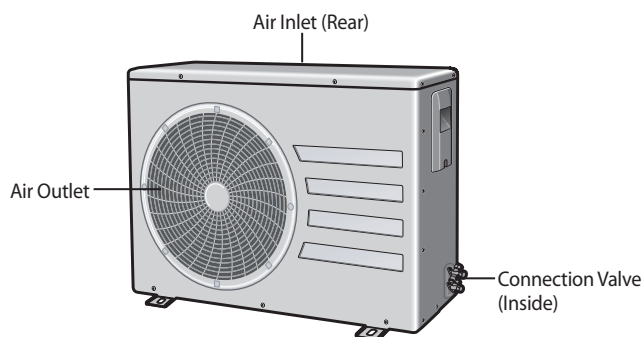

Remote Control - Buttons and Display

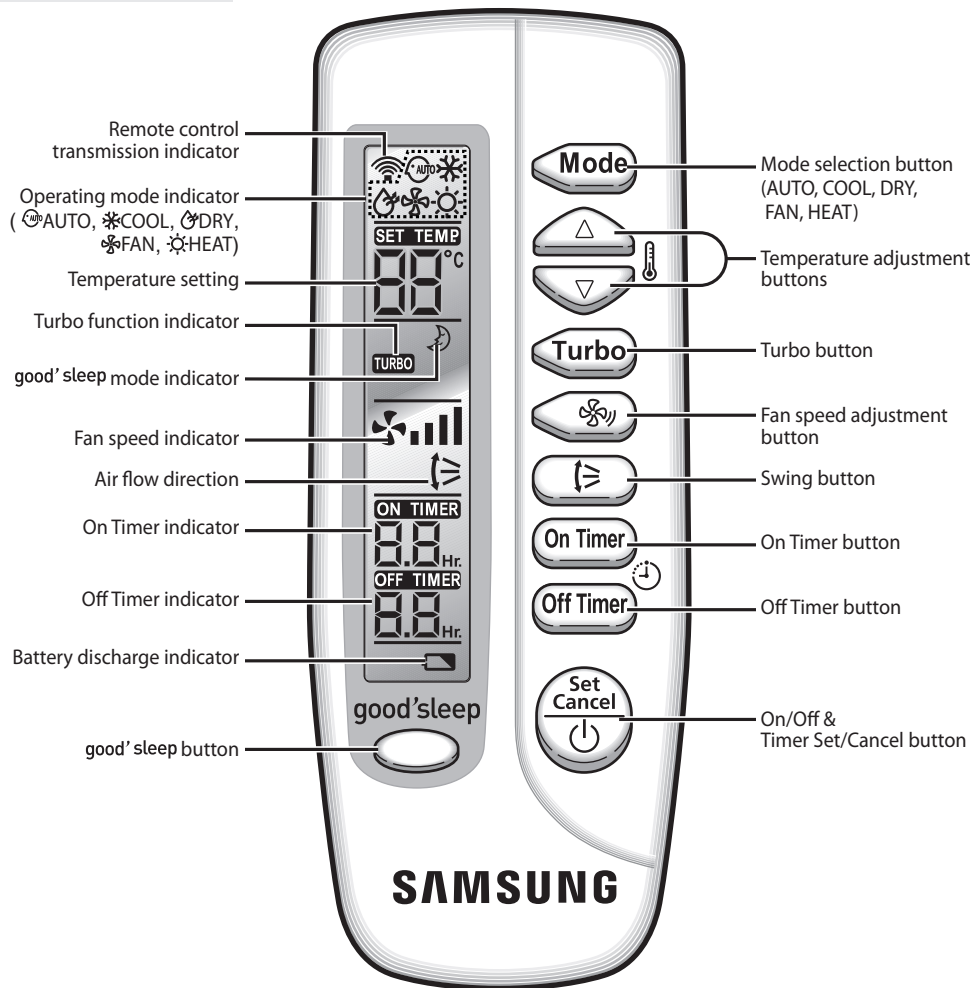

Inserting the Remote Control Batteries

You must insert or replace the remote control batteries when:

- ◆ **You purchase the air conditioner**
- ◆ **The remote control does not work correctly**

Note

- ◆ Use two AAA, LR03 1.5V batteries.
- ◆ Do not use old and new batteries or different kinds of batteries together.
- ◆ Insert two batteries correctly as indicated by the + and - symbols.

- 1 Remove the battery cover in the rear of the remote control by pushing it with your thumb.

- 2 Insert two batteries, respecting the polarities as indicated by the + and - symbols.

- 3 Close the cover by sliding it back in place.

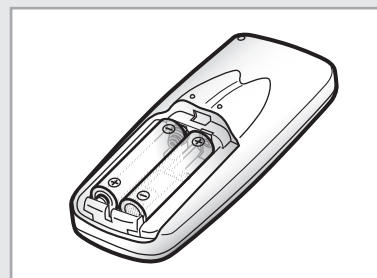
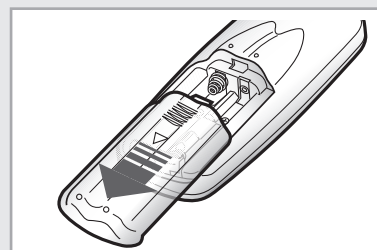



Getting Started

The User's Manual provides you with valuable information about your air conditioner. In order to take full advantage of the air conditioner's features, please read this manual carefully before using.

You have already seen the basic description of the unit on pages from 8 to 10. Starting with the next page, you will find a series of step-by-step procedures for each function available.

The illustrations in the step-by-step procedures use three different symbols:

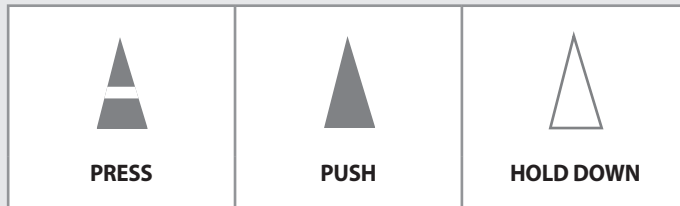



Selecting Auto Mode

You can select Auto mode if you want to cool or heat your room automatically. You can adjust the temperature in this mode.

- 1 Press the  (On/Off) button.

Result:

- ◆ The operation indicator on the indoor unit lights up.
- ◆ The air conditioner starts up in the mode you selected last.
- ◆ The indoor unit beeps.

- 2 Press the  button on the remote control until  is displayed.

Result:

- ◆ The indoor unit beeps each time you press the  button.
- ◆ The air conditioner runs in Auto mode.
- ◆ Auto mode cools or heats the room depending on the set temperature.
- ◆ The air conditioner changes from Cool or Heat mode automatically, depending on the current temperature.

Note You can change modes at any time.

- 3 Press the  button to adjust the temperature until the required temperature is displayed. You can set the temperature between 16°C and 30°C.

Result:

- ◆ Each time you press the  button:
 - The temperature adjusts by 1°C
 - The indoor unit beeps

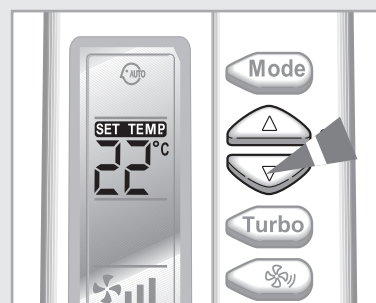
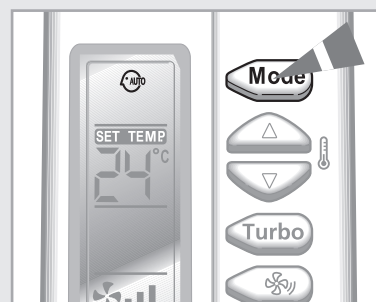

Selecting Cool Mode

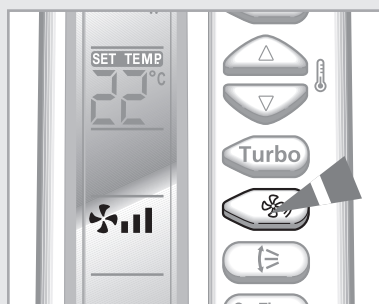
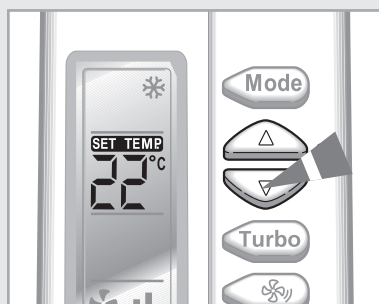
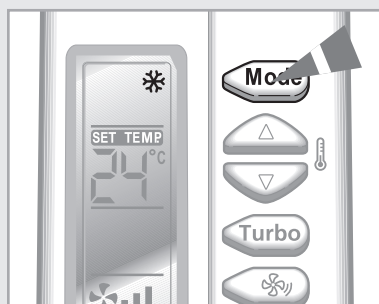

You can select Cool mode if you want to cool your room.

You can adjust the temperature and the fan speed when cooling.

- 1 Press the (On/Off) button.

Result:

- ◆ The operation indicator on the indoor unit lights up.
- ◆ The air conditioner starts up in the mode you selected last.
- ◆ The indoor unit beeps.

- 2 Press the button on the remote control until is displayed.

Result:

- ◆ The indoor unit beeps each time you press the button.
- ◆ The air conditioner runs in Cool mode.

Note You can change modes at any time.

- 3 Press the button to adjust the temperature until the required temperature is displayed.

You can set the temperature between 16°C and 30°C.

Result:

- ◆ Each time you press the button:
 - The temperature adjusts by 1°C
 - The indoor unit beeps
- ◆ If the room temperature is higher than the selected temperature, the air conditioner starts cooling.
- ◆ If the room temperature reaches the set temperature, the air conditioner stops cooling, but the fan continues to operate.

- 4 Press the button to select the fan speed until the required setting is displayed.

Automatic (rotated : = =)
 Low
 Medium
 High
 Maximum

Result: Each time you press the button, the indoor unit beeps.

- 5 To control the airflow direction, refer to page 21.



Selecting Heat Mode

**You can select Heat mode if you want to heat your room.
You can adjust the temperature and the fan speed when heating.**

- 1 Press the  (On/Off) button.

Result:

- ◆ The operation indicator on the indoor unit lights up.
- ◆ The air conditioner starts up in the mode you selected last.
- ◆ The indoor unit beeps.

- 2 Press the  button on the remote control until  is displayed.

Result:

- ◆ The indoor unit beeps each time you press the  button.
- ◆ The air conditioner runs in Heat mode.

Note You can change modes at any time.





- 3 Press the  button to adjust the temperature until the required temperature is displayed.

You can set the temperature between 16°C and 30°C.

Result:

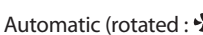
- ◆ Each time you press the  button:
 - The temperature adjusts by 1°C
 - The indoor unit beeps
- ◆ If the room temperature reaches 5°C higher than the set temperature, the air conditioner stops heating, but the fan continues to operate.
- ◆ If the room temperature reaches 3°C lower than the set temperature, the air conditioner starts heating again.

- 4 Press the  button to select the fan speed until the required setting is displayed.

 Automatic (rotated : )
 Low
 Medium
 High
 Maximum

Result:

- ◆ Each time you press the  button, the indoor unit beeps.
- ◆ For the first 3~5 minutes, the fan may not operate to prevent cool air from flowing out of the indoor unit.
This helps to warm the air in your room sufficiently.

- 5 To control the airflow direction, refer to page 21.

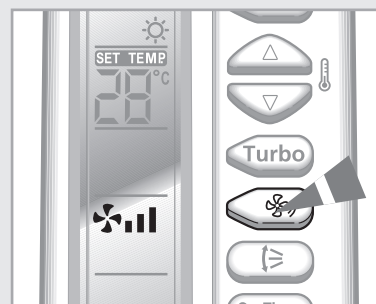
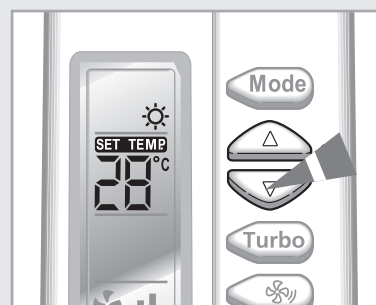
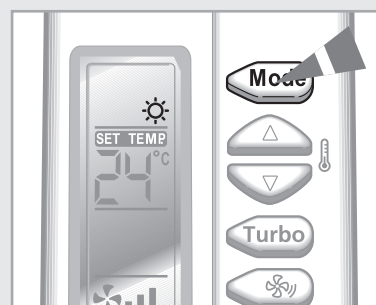

Selecting Dry Mode

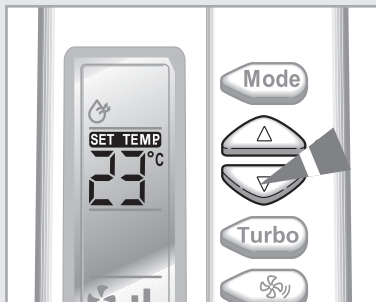
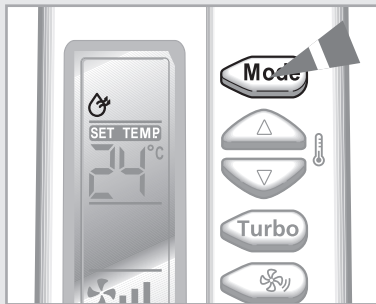



**Select Dry mode if you want to dehumidify your room.
You can adjust the temperature in this mode.**

- 1 Press the  (On/Off) button.

Result:

- ◆ The operation indicator on the indoor unit lights up.
- ◆ The air conditioner starts up in the mode you selected last.
- ◆ The indoor unit beeps.

- 2 Press the  button on the remote control until  is displayed.

Result:

- ◆ The indoor unit beeps each time you press the  button.
- ◆ The air conditioner runs in the Dry mode.

Note You can change modes at any time.

- 3 Press the  button to adjust the temperature until the required temperature is displayed.
You can set the temperature between 16°C and 30°C.

Result:

- ◆ Each time you press the  button:
 - The temperature adjusts by 1°C
 - The indoor unit beeps
- ◆ The air conditioner starts dehumidifying and the fan speed adjusts automatically.

- 4 To control the airflow direction, refer to page 21.



Selecting Fan Mode

Select Fan mode if you want to ventilate your room. It helps to refresh the air in your room. You can adjust the fan speed in this mode.

- 1 Press the  (On/Off) button.

Result:

- ◆ The operation indicator on the indoor unit lights up.
- ◆ The air conditioner starts up in the mode you selected last.
- ◆ The indoor unit beeps.

- 2 Press the  button on the remote control until  is displayed.

Result:

- ◆ The indoor unit beeps each time you press the  button.
- ◆ The air conditioner runs in Fan mode.
- ◆ The temperature is set automatically.

Note You can change modes at any time.

- 3 Press the  button to select the fan speed until the required setting is displayed.

 Low
 Medium
 High

Result: Each time you press the  button, the indoor unit beeps.

- 4 To control the airflow direction, refer to page 21.

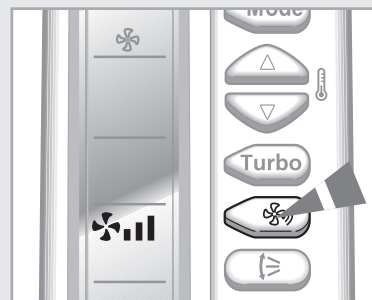
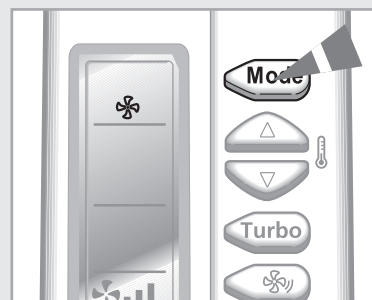

Selecting good' sleep Mode

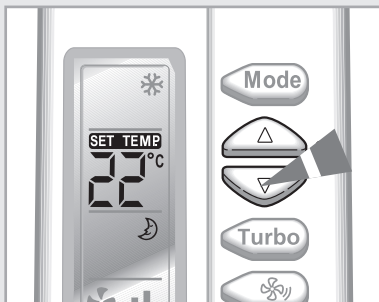
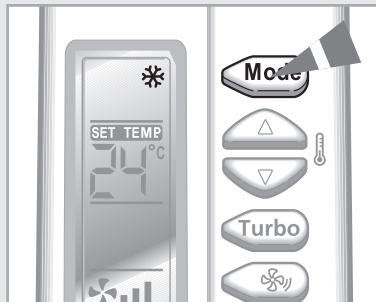



good' sleep mode helps users to fall asleep well after going to bed whether being too hot to sleep or being awakened by coldness. The good' sleep mode can be selected only when the air conditioner is switched on in cool/heat mode.

- 1 Press the  (On/Off) button.

Result:



- ◆ The operation indicator on the indoor unit lights up.
- ◆ The air conditioner starts up in the mode you selected last.
- ◆ The indoor unit beeps.



- 2 Press the  button to select  or  mode.

Result:

- ◆ The indoor unit beeps each time you press the  button.
- ◆ The air conditioner runs in cool or heat mode.

- 3 Press the  button.

- The remote control display shows you that this mode automatically stops after 8-hour operation.
- In the case of adjusting time
 - ◆ Press the  button to adjust desired operation time from 30 minutes to 12 hours.**good' sleep mode will automatically stop after the set time.**
 - ◆ Press the  button.

Result: In the case of adjusting the extra time for **good' sleep mode**, you should press the  button within 10 seconds. If you do not press the  button within 10 seconds, **good' sleep mode** will automatically stop in 8-hour operation.

- 4 Press the  button to adjust the temperature until the desired temperature is displayed. You can set the temperature between 16°C and 30°C.

Result: Each time you press the  button;

- The temperature adjusts by 1°C
- The indoor unit beeps

Temperature changes in good' sleep mode

To prevent excessive cooling/heating during sleep, the **good' sleep** mode automatically modifies the temperature setting in accordance with the time setting. Temperature and air current change according to the three stages; Falling asleep, Sound sleep, and Waking up from **good' sleep** mode, and then the air conditioner will automatically turn off when the set time has elapsed.

Three stage **good' sleep** prevents you from having difficulty sleeping on extremely hot/cold nights.

① **Falling asleep** : Eases you into sleep by dropping the temperature.

② **Sound sleep** : Relaxes your body and raises your temperature slightly.

③ **Waking up from good' sleep mode** :

Allows you to wake up to comfortable crisp air making you feel refreshed and energized.

- Set the Off timer in **good' sleep** mode for more than 5 hours. Sleep may be disturbed if the **good' sleep** mode is set for too short or too long a time because the temperature changes are set to an 8-hour cycle.
- If the **good' sleep** mode is set for less than 4 hours, the operation will stop at the set time. If the **good' sleep** mode is set for over 5 hours, the last hour will run in Waking Up stage before shutting off.
- Recommended set temperature is between 25°C~27°C for cooling and 21°C~23°C for heating.

Cool mode

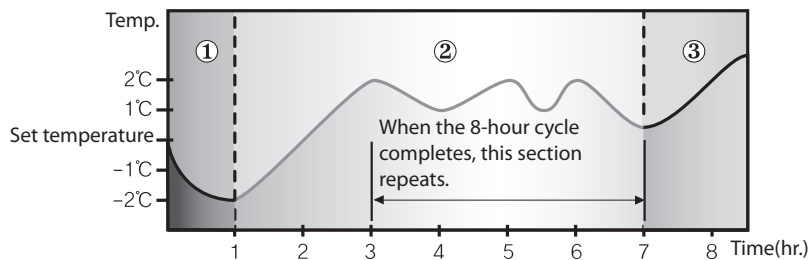

Heat mode

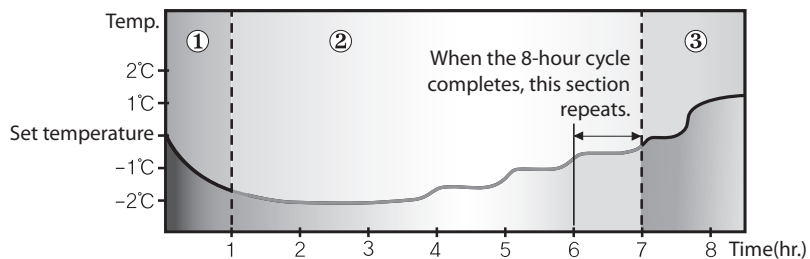

Selecting the Turbo Function

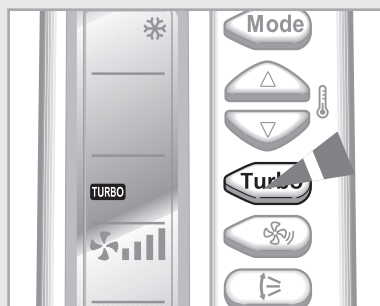

You can select the Turbo Function if you want to cool or heat your room as quickly as possible. The Turbo function operates for 30 minutes with the maximum settings before returning automatically to the mode and temperature previously selected.

- 1 Press the  (On/Off) button.

Result:

- ◆ The operation indicator on the indoor unit lights up.
- ◆ The air conditioner starts up in the mode you selected last.
- ◆ The indoor unit beeps.

- 2 Press the  button.

Result:

- ◆ The temperature and fan settings are adjusted automatically.
- ◆ The air conditioner cools or heats the room as quickly as possible.
- ◆ After 30 minutes, the air conditioner is reset automatically to the previous setting.
- ◆ You can select the Turbo function in Auto, Cool and Heat mode. If you select this function in Dry or Fan mode, the mode changes to Auto mode.

- 3 Press the  button again to stop the Turbo Function before the end of the 30-minute period.

Result: The air conditioner is reset automatically to the previous setting.

- 4 To control the airflow direction, refer to page 21.

Adjusting the Airflow Direction Vertically

You can adjust the airflow direction vertically. The outer airflow blade moves up and down to increase the efficiency of the cooling or heating operation.

- 1 Press the  button until the required direction is set.

Result: The outer blade is adjusted vertically.

- 2 Press the  button again to move the blade up and down automatically during operation.

- 3 Press the  button again to stop the blade moving up and down.

<i>Note</i>	<i>If you turn the air conditioner...</i>	<i>Then the blade...</i>
	Off	is closed completely.
	On	set to the default position.

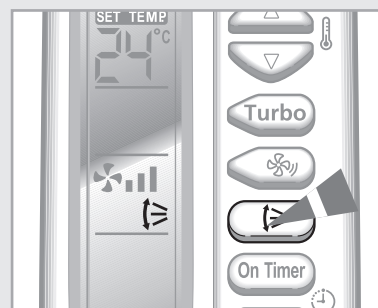

Adjusting the Airflow Direction Horizontally

You can adjust airflow direction horizontally manually. The inner blades with small fins move the air in the desired direction.

- 1 Adjust the inner blades by moving them left or right.
 - ◆ Make sure do not touch the inner blades during operation. It may cause injury on your fingers.

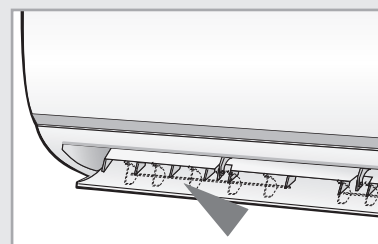

Setting the On Timer

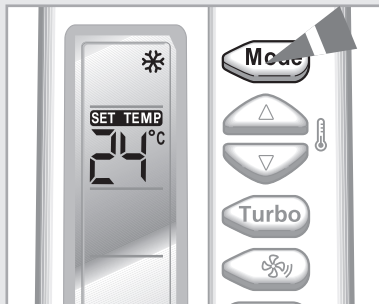
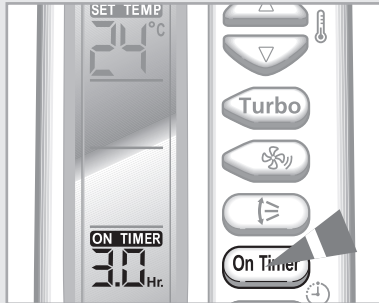

You can set the On Timer to turn on the air conditioner automatically at the appointed time within a range of 30 minutes to 24 hours.

- 1 Press the **On Timer** button until the desired time is displayed to set the On Timer. You can set the time between 0.5 hour and 24 hours.

- 2 Press the **Set/Cancel** button to complete the setting.

Result:

- ◆ The remaining time is displayed.
- ◆ The timer indicator stops blinking.
- ◆ The selected mode and the temperature on the display disappear after 10 seconds.
- ◆ The air conditioner turns on automatically at the appointed time and the On Timer setting disappears.

- 3 Press the **Mode** button until the desired mode is displayed at the top of the remote control to select the mode in advance.

Result: The air conditioner operates in the selected mode when it is turned on.

To Cancel the On Timer

If you no longer wish to use the On Timer that you have set, you can cancel it at any time.

- 1 To cancel the On Timer, press the **On Timer** button one or more times until the timer setting disappears.

- 2 Press the **Set/Cancel** button.

Note If you want to turn on the air conditioner before the timer reaches the setting time, press the **Set/Cancel** button.

Setting the Off Timer





You can set the Off Timer to turn off the air conditioner automatically at the appointed time within a range of 30 minutes to 24 hours.

- 1 Press the  button until the desired time is displayed to set the Off Timer. You can set the time between 0.5 hour and 24 hours.

- 3 Press the  button to complete the setting.



- Result:**
- ◆ The remaining time is displayed.
 - ◆ The timer indicator stops blinking.
 - ◆ The air conditioner turns off automatically at the appointed time and the Off Timer setting disappears.

Example If you would like to turn the air conditioner on after 2 hours and to operate it for 2 hours during non-operation:

1. Press the  button until '2.0 Hr' is displayed.
2. Press the  button.
3. Press the  button until '4.0 Hr' is displayed.
4. Press the  button.

Note If you would like to turn on the air conditioner and then to turn off it automatically at the appointed time by using On/Off Timer during operation, you should set the On Timer longer than the Off Timer.

Caution Make sure that the air conditioner will not continue to run after On Timer setting is confirmed.

- Note**
- ◆ You can check or change the mode and/or the temperature by pressing the  button or the  button after setting the Off Timer.
 - ◆ If you would like to turn off the air conditioner and then to turn on it again automatically at the appointed time by using On/Off Timer during non-operation, you should set the Off Timer longer than the On Timer.

To Cancel the Off Timer

If you no longer wish to use the Off Timer that you have set, you can cancel it at any time.

- 1 To cancel the Off Timer, press the  button one or more times until the timer setting disappears.

- 2 Press the  button.

Note If you want to turn off the air conditioner before the timer reaches the setting time, press the  button.



Operating Your Air Conditioner Without the Remote Control

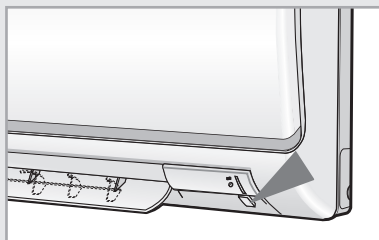

Your air conditioner can be operated directly from the indoor unit if the remote control is lost or broken.

- 1 To switch the air conditioner on, press the ON/OFF switch on the right side of the indoor unit.

Result:

- ◆ The OPERATION indicator on the indoor unit comes on.
- ◆ The indoor unit beeps.
- ◆ The air conditioner starts up in the most suitable mode for the room temperature. The mode may change from cooling into heating, from heating into cooling depending on the current temperature during operation:

Room Temperature Operating Mode

Less than 24°C	Heat
24°C or above	Cool

- 2 To switch the air conditioner off, press the ON/OFF switch again.

Note Even if the air conditioner has been switched on via the ON/OFF switch, operations can still be controlled using the remote control as usual.

Cleaning Your Air Conditioner

To get the best possible use out of your air conditioner, you must clean it regularly to remove the dust that accumulates on the air filter.

IMPORTANT Before cleaning your air conditioner, ensure that you have switched off the breaker used for the unit.

- 1 Open the upper front grille by pulling the lower right and left tabs of the grille.
- 2 Pull air filters out of each tab of the grille.
- 3 Remove all dust on the air filters with a vacuum cleaner or brush.
- 4 When you finished, insert air filters by fixing it to each tab of the grille.
- 5 To close the front grille, fix it to hooks and push down the lower right and left tabs of the grille.
- 6 Clean the front grille with a damp cloth and mild detergent (do NOT use benzene, solvents or other chemicals).

Note If you have not used the air conditioner for a long period of time, set the fan going for three to four hours to dry the inside of the air conditioner thoroughly.

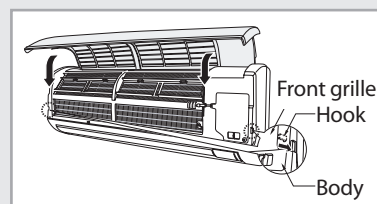
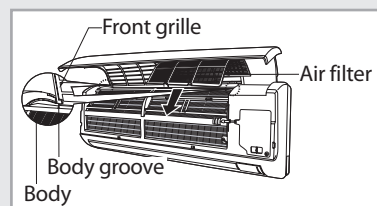
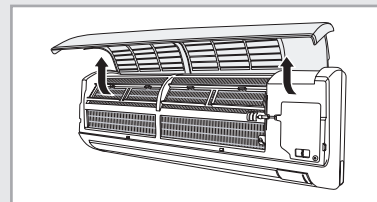

Cleaning Deodorizing and Bio filter (Option)

To remove minute dust particles and odors, deodorizing and Bio filter are installed in the air conditioner. You should clean the filters every 3 months.

- 1 Open the upper front grille by pulling the lower right and left tabs of the grille.
- 2 Pull out the deodorizing and Bio filter.
- 3 Wash the filters with clean water, then dry them in the shade.
- 4 Insert the filters into the original position.

Note You can change the position of filters with each other.

- 5 Close the front grille.

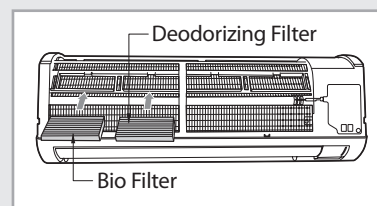

Temperature and Humidity Ranges

The table below indicates the temperature and humidity ranges the air conditioner can be operated within. Refer to the table for efficient use.

MODE	OPERATING CONDITIONS	IF OUT OF CONDITIONS
COOL	Indoor temp: 16°C~32°C	- A safety device will stop continuously the system functioning; - Condensation may occur on the indoor unit with risk to have either water blow off or drops on the floor;
	Indoor humidity: below 80%	
	Outdoor temp: 21°C~43°C	
HEAT	Indoor temp: below 27°C	- A safety device will stop continuously the system functioning;
	Outdoor temp: 0°C~24°C	
DRY	Indoor temp: 16°C~32°C	- A safety device will stop continuously the system functioning; - Condensation may occur on the indoor unit with risk to have either water blow off or drops on the floor;
	Indoor humidity: below 80%	
	Outdoor temp: 18°C~43°C	
POWER SUPPLY	Single phase rated voltage minimum and maximum limit	220V-240V~50Hz 198V min.-264V max.

* **Any damage occurs out of condition specified cannot be covered by product warranty.**
If the system works continuously outside of conditions, its performance and reliability will be compromised.



Operating Recommendations

When you use your air conditioner, it is recommended that you read the following:

Topic	Recommendation
Heating capacity	The heat pump inside the air conditioner absorbs heat from outside air and brings it indoors. If the temperature of the outside air drops, the air conditioner heats less. If the room is not warm enough, use an additional heating appliance.
Warm air circulation	The air conditioner circulates warm air to heat your room. It will take some time to warm the air in your room entirely after the air conditioner turns on. Therefore, turn the air conditioner on in advance.
Frost	When you select the Heat mode, frost may form in the outdoor unit due to low temperature and high humidity. If this happens: ◆ The heating operation is stopped. ◆ The air conditioner defrosts automatically for about 7 minutes. After about 7 minutes, the air conditioner starts operating again normally.
High indoor and outdoor temperatures	If both the indoor and outdoor temperatures are high when you select the Heat mode, the fan and the compressor of the outdoor unit may stop periodically. This is normal; wait until the air conditioner turns on again.
Power failure	If a power failure occurs when the air conditioner is operating, the air conditioner will turn off. When the power returns, the air conditioner will start up again automatically.
Protection mechanism	When the air conditioner is started immediately after being plugged in or stopped, the normal operation starts up after 3 minutes for the reason of protection.

Solving Common Problems

Before contacting the after-sales service, perform the following simple checks. They may save you the time and expense of an unnecessary call.

Problem	Explanation/Solution
The air conditioner does not operate at all.	<ul style="list-style-type: none"> ◆ Check if power is on and operate the air conditioner again. ◆ Check if the circuit breaker is switched off. ◆ Check if Off Timer is set.
The temperature is not adjusted.	<ul style="list-style-type: none"> ◆ Check if you selected the Fan mode.
The air conditioner does not operate in the HEAT mode.	<ul style="list-style-type: none"> ◆ Check if the air conditioner is cooling only model. ◆ Check if the remote control is for cooling only model.
The cool(warm) air does not come out from the air conditioner.	<ul style="list-style-type: none"> ◆ Check if set temperature higher(lower) than current temperature. ◆ Check if you selected the Fan mode. Select the Cool, Heat, Auto or Dry mode. ◆ Check if the air filter is blocked by dirt. Clean the air filter regularly. ◆ Check if there is cover on the outdoor unit or any obstacle. Remove the cover or obstacle. ◆ Check if you installed the air conditioner under direct sunlight. ◆ The window or door may be opened. ◆ Check if you turn on the air conditioner just now. It takes about 3 minutes to cool or heat the room. ◆ Check if the drain pipe is too long.
The fan speed is not adjusted.	<ul style="list-style-type: none"> ◆ In Dry mode, the fan speed is selected automatically.
The remote control does not operate.	<ul style="list-style-type: none"> ◆ Check if the battery is discharged. Replace the battery. ◆ Check if the remote control sensor is blocked. ◆ Check if the air conditioner is placed near strong light.
The Timer is not set.	<ul style="list-style-type: none"> ◆ Check if you pressed the  button after selecting time.
Odor is permeated in the room during operation.	<ul style="list-style-type: none"> ◆ Check if you use the air conditioner in smoky area or there is a smell. Ventilate the room or select the Fan mode for 1~2 hours.
The indoor unit indicator flashes.	<ul style="list-style-type: none"> ◆ Press the  button to turn on the air conditioner again. Switch the circuit breaker off and switch on it again.
Strange sound is heard from the air conditioner.	<ul style="list-style-type: none"> ◆ The sound is heard when the refrigerant gas flow is changed depending on the use of the air conditioner. ◆ When you press the  button, noise may be heard that the air conditioner sense the airflow blade.
Water drops from the outdoor unit connection part.	<ul style="list-style-type: none"> ◆ Water may form due to the difference of the temperature.

AUTO-DIAGNOSTIC FUNCTION

This air conditioner has an auto-diagnostic function in case a failure will happen. When error occurs, the Lamp will blink.

Before contacting customer call center green number, please ask to installer to make a double check of installation unless there's a full evidence of SAMSUNG product problem.



ELECTRONICS

Contact SAMSUNG WORLD WIDE

If you have any comments or questions regarding a Samsung product, contact the SAMSUNG customer care center.

Country	Customer Care Center 	Web Site
BELGIUM	0032 (0)2 201 24 18	www.samsung.com/be
CZECH REPUBLIC	844 000 844	www.samsung.com/cz
DENMARK	70 70 19 70	www.samsung.com/dk
FINLAND	030-6227 515	www.samsung.com/fi
FRANCE	3260 SAMSUNG(726-7864) 08 25 08 65 65 (€0,15/min)	www.samsung.com/fr
GERMANY	01805 - 121213 (€0,14/min)	www.samsung.de
HUNGARY	06-80-SAMSUNG (726-7864)	www.samsung.com/hu
ITALIA	800 SAMSUNG (726-7864)	www.samsung.com/it
LUXEMBURG	0035 (0)2 261 03 710	www.samsung.com/be
NETHERLANDS	0900 20 200 88 (€0,10/min)	www.samsung.com/nl
NORWAY	815-56 480	www.samsung.com/no
POLAND	0 801 801 881 022-607-93-33	www.samsung.com/pl
PORTUGAL	80 8 200 128	www.samsung.com/pt
SLOVAKIA	0800-SAMSUNG (726-7864)	www.samsung.com/sk
SPAIN	902 10 11 30	www.samsung.com/es
SWEDEN	0771-400 200	www.samsung.com/se
U.K	0870 SAMSUNG (726-7864)	www.samsung.com/uk
REPUBLIC OF IRELAND	0818 717 100	www.samsung.com/ie
AUSTRIA	0800-SAMSUNG(726-7864)	www.samsung.com/at
SWITZERLAND	0800-SAMSUNG (726-7864)	www.samsung.com/ch

© Samsung Electronics Co., Ltd. All Rights Reserved.





USER'S MANUAL

- AQ09F* Series
- AQ12F* Series
- AQ18F* Series
- AQ24F* Series
- AQ09N* Series
- AQ12N* Series
- AQ18N* Series
- AQ24N* Series
- AQ09S* Series

ENGLISH

ESPAÑOL

FRANÇAIS

ITALIANO

PORTUGUÊS

DEUTSCH

ΕΛΛΗΝΙΚΑ

Split - type Air Conditioner (Cooling and Heating)



© S F I P D G DB98-28591A(1)

