



**SAMSUNG**

# CLOTHES DRYER

## Technical Information

**IMPORTANT SAFETY NOTICE – “For Technicians only”** This service data sheet is intended for use by persons having electrical, electronic, and mechanical experience and knowledge at a level generally considered acceptable in the appliance repair trade. Any attempt to repair a major appliance may result in personal injury and property damage. The manufacturer or seller cannot be responsible, nor assume any liability for injury or damage of any kind arising from the use of this data sheet.

- Due to possibility of personal injury or property damage, always contact an authorized technician for servicing or repair of this unit.
- Refer to Service Manual (DV431A\*\*/XEU) for detailed installation, operating, testing, troubleshooting, and disassembly instructions.

 **CAUTION**

All safety information must be followed as provided in Service Manual of DV431A\*\*/XEU.

 **WARNING**

To avoid risk of electrical shock, personal injury or death; disconnect power to dryer before servicing, unless testing requires power.

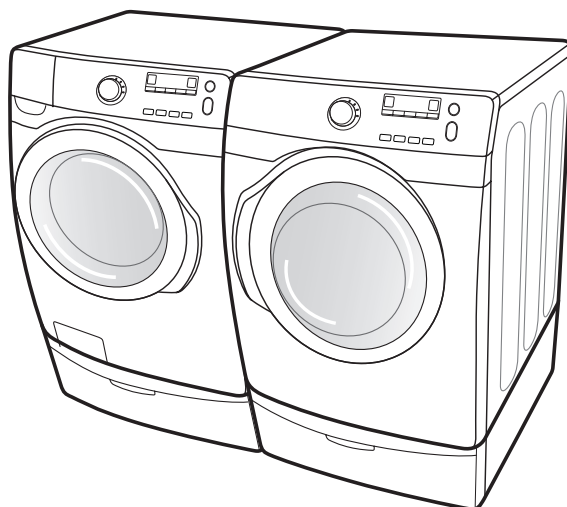

Code No. : DC68-02365F-01

# ALIGNMENT AND ADJUSTMENTS

## **WARNING**

To avoid risk of electrical shock, personal injury or death; disconnect power to dryer before servicing, unless testing requires power.

## ERROR ITEMS AND DIAGNOSTIC CODES

An occurrence of an Error will make a sound of error melody for 5sec and continuously show one of the Error Displays from the following errors.

Error Display	Trigger	Action Taken
<b>tE</b>	The Termistor resistance is very low or high.	Check for: - Clogged lint screen. - Restricted vent system. - Check Thermistor resistance.
<b>HE</b>	Invalid heating Temp in running the dryer	Check for: - Restricted vent system. - Check Thermistor resistance.
<b>dE</b>	Running the dryer with door open	Check for: - Close the door, and run the dryer. - Loose or open wire terminals in Door Sense circuit.
<b>dF</b>	Invalid door state for more than 256 milliseconds	Check for: - Loose or open wire terminals in Door Sense circuit.
<b>bE2</b>	Invalid state of key circuit short for 30 secs	Check for: - Display PCB key circuit short or not.
<b>FE</b>	Invalid power source Frequency	Check for: - Not using regular power source frequency - Invalid power frequency sense circuit
<b>AE</b>	Electronic Control Problem (Communication Error)	Check for: - Check PCB and Wire harness. - Replace PCB.
<b>Et</b>	Invalid state of Eeprom communication	Check for : - PCB with Eeprom circuit.

# ALIGNMENT AND ADJUSTMENTS

## WARNING

To avoid risk of electrical shock, personal injury or death; disconnect power to dryer before servicing, unless testing requires power.

## TEST MODE

### Service Mode (DV431 only)

#### How to enter:

- To enter Service Mode , press Mixed Load Bell + Temp. Keys 3 seconds in normal mode until it sends out a beeping sound.
- If pressing Mixed Load Bell + Temp. Keys in Service mode , it will return Normal mode.
- Even though entering Service mode, the operating cycle will not be influenced.

### Touch Sensor Data Display Mode

#### Definition of Touch Sensor Data Display Mode:

- This mode is default mode of entering service mode.

#### How to enter:

- With Power On pressing Mixed Load Bell +Temp(DV431) or Wrinkle Prevent + Temp(DV231) for 3 seconds.
- This action will put the dryer into sensor bar touch data mode
- Dryer will display Sensor Bar data.

### Cycle Count Mode

#### Definition of Cycle Count Mode:

- This mode is to bring up the total number of cycles that User have carried out.

#### How to enter:

- Press the Mixed Load Bell(DV431) orTime(DV231) key in Service Mode.

### Software Revision Mode

#### Definition of Software Revision Mode:

- It is to retrieve its software version

#### How to enter:

At Service Mode, press Temp until it sends out a beeping sound

ex) In case of "U1 05", U1 means major version "U1", 05 means minor version "05".

- If press Temp key In Software Version Mode, it will return Service Mode.

# ALIGNMENT AND ADJUSTMENTS

## WARNING

To avoid risk of electrical shock, personal injury or death; disconnect power to dryer before servicing, unless testing requires power.

## Continuous Run Mode



### How to enter:

- Press Mixed Load Bell + Dry Level (DV431) or Wrinkle Prevent + Time (DV231) for 7 sec during Power On State (normal user mode).
- Once in Continuous Run Mode, display "CC" for 1 sec and the remaining time for 2 sec in turns.
- The previous cycle will restart during Continuous Run Mode until the mode is deactivated.
- During Continuous Run Mode, press Mixed Load Bell + Dry Level (DV431) or Wrinkle Prevent + Time (DV231) for 7 seconds to go back to normal user mode.

## Data Display Mode (DV431 only)

### How to Enter:

- With Power On, press AdjustUp Key + AdjustDown Key for 7 seconds until it sends out a beeping sound.
- If not pressed any keys for 5 minutes, it will be set back from Data Display Mode
- If pressing AdjustUp Key in this mode, Display Mode will be increased.
- If pressing AdjustDown Key in this mode, Display Mode will be decreased.

### Definition of Data Display Mode:

- Display Mode 1 : Temperature data
- Display Mode 2 : Average Touch Sensor data for 1 minute
- Display Mode 3 : Average Temperature data for 1 minute

# ALIGNMENT AND ADJUSTMENTS

## WARNING

To avoid risk of electrical shock, personal injury or death; disconnect power to dryer before servicing, unless testing requires power.

## TROUBLE DIAGNOSIS

- As the micom dry machine is configured of the complicate structure, there might be the service call.

Below information is prepared for exact trouble diagnosis and suitable repair guide.

## Caution for the Repair and Replacement

Please follow below instruction for the trouble diagnosis and parts replacement.

- 1) As some electronic components are damaged by the charged static electricity from the resin part of dryer or the human body, prepare the human body earth or remove the potential difference of the human body and dryer by contacting the power supply plug when the work contacting to PCB is executed.

POWER SUPPLY PLUG

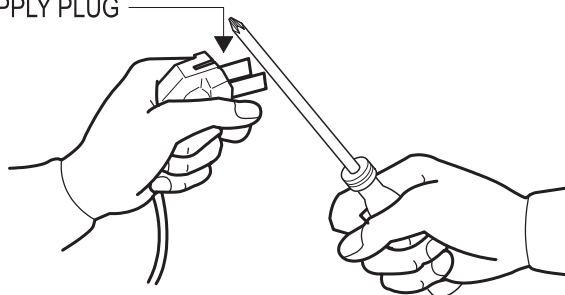

- 2) As the P.C.B assembly is designed for no trouble, do not replace the P.C.B assembly by the wrong diagnosis and follow the procedure of the trouble diagnosis when the micom is not operated normally.

# TROUBLE SHOOTING

## WARNING

To avoid risk of electrical shock, personal injury or death; disconnect power to dryer before servicing, unless testing requires power.

No	Problem	What To Do
1	<b>Will Not Start or Run</b>	<ul style="list-style-type: none"> <li>• All wires are hooked up to their corresponding terminals.</li> <li>• Dryer is plugged in.</li> <li>• Blown fuse or circuit breaker.</li> <li>• Door switch functional...door closed. Check for error code 3 (See Table for codedefinition).</li> <li>• Start/Pause rotary selector dial functional.</li> <li>• Control Board operational.</li> <li>• Belt off or broken and Belt Cut-off Switch operates.</li> <li>• Drive motor functional.</li> <li>• Check motor winding resistance: 2.88ohms between pin #3 and 4, 3.5ohms between pin #4 and 5.</li> </ul>
2	<b>Motor runs/ tumbler will not turn</b>	<ul style="list-style-type: none"> <li>• Belt off or broken/damaged.</li> <li>• Idler tension spring too weak or stretched.</li> <li>• Idler pulley jammed or stuck.</li> </ul>
3	<b>Runs a few minutes and then stops</b>	<ul style="list-style-type: none"> <li>• Lint buildup around drive motor.</li> <li>• Low voltage present.</li> <li>• Blower impeller blocked in blower housing.</li> <li>• Drive motor - start switch contacts stuck closed.</li> </ul>
4	<b>Blows fuses or trips circuit breaker</b>	<ul style="list-style-type: none"> <li>- Is the belt connected well?</li> <li>- Is the winding of the motor continuous? (Rotor winding, stator winding, generator)</li> <li>- Is the motor protector normal?</li> <li>• If above points are not found, the PCB assembly is out of order. Replace it.</li> </ul>
5	<b>Blows fuses or trips circuit breaker (Gas Model)</b>	<ul style="list-style-type: none"> <li>• During ignition the dryer will draw X amps. With the burner ON, the dryer will draw X amps. If the dryer is drawing amperages above this, then the house wiring, fuse box or circuit breaker is suspected to be at fault.</li> <li>• Igniter harness loose and shorted to base.</li> <li>• Incorrect wiring or wire shorted to ground.</li> <li>• Drive motor winding shorting to ground.</li> </ul>
6	<b>Will not heat (motor runs)</b>	<p>Open heating element.</p> <ul style="list-style-type: none"> <li>• Hi-Limit trips easily or is open.</li> <li>• Regulating thermostat trips easily or is open.</li> <li>• Membrane switch open.</li> <li>• Check Thermistor.</li> </ul>
7	<b>Will Not Dry Gas Model Poor Gas Ignition</b>	<p>When the dryer is operated on a heat setting, the igniter should be energized and burner shall fire within 45 seconds at 120 VAC. The failure of a component in this system will usually be indicated by one of three symptoms:</p>

# TROUBLE SHOOTING

## WARNING

To avoid risk of electrical shock, personal injury or death; disconnect power to dryer before servicing, unless testing requires power.

No	Problem	What To Do
8	<b>The igniter does not glow</b>	<p>If the igniter does not heat up, remove power and using an ohmmeter, check the following:</p> <ul style="list-style-type: none"> <li>• Open flame sensor</li> <li>• Open igniter</li> <li>• Shorted booster coil</li> <li>• Open wiring</li> <li>• Bad motor switch ( Neutral supply)</li> <li>• No power from control ( L1 supply)</li> </ul>
9	<b>Igniter glows - No gas ignition</b>	<p>If the igniter heats up but the main burner flame is not ignited, remove power and using an ohmmeter, check the following:</p> <ul style="list-style-type: none"> <li>• Open secondary coil</li> <li>• Open holding coil</li> <li>• Open wire harness</li> <li>• Stuck flame sensor (Stuck closed)</li> </ul>
10	<b>The gas is ignited but the flame goes out</b>	<p>If a normal ignition takes place and after a short while the flame goes out, check for the following:</p> <ul style="list-style-type: none"> <li>• Radiant sensor contacts opening prematurely.</li> <li>• Weak gas valve coil may open when stressed by higher Temps.</li> <li>• Weak Hi-Limit</li> <li>• Poor venting</li> <li>• Bad drum seals</li> </ul>
11	<b>Improper drying clothes wrinkled Rough texture long dry time</b>	<ul style="list-style-type: none"> <li>• Lint filter is not clean.</li> <li>• Restriction in exhaust.</li> <li>• Outside exhaust hood damper door stuck closed.</li> <li>• Exhaust too long, too many elbows, flex ductwork installed.</li> <li>• Poor intake air available for the dryer.</li> <li>• Incorrect tumbler speed. Tumbler belt slipping.</li> <li>• Blower impeller bound; check for foreign material in blower area.</li> <li>• Customer overloading dryer.</li> <li>• Check clothing labels for fabric content and cycle selected.</li> <li>• Clothes too wet due to insufficient spin out by washer.</li> </ul>
12	<b>Noisy and/Or Vibration</b>	<ul style="list-style-type: none"> <li>• Thumping Check for loose tumbler baffle, rear tumbler roller(s) worn or misaligned, out-of-round tumbler or high weld seam on tumbler.</li> <li>• Ticking Check for loose wire harness or object caught in blower wheel area.</li> <li>• Scraping Check for front or rear bulkhead felt seal out of position or worn tumbler front bearings.</li> <li>• Roaring Check for blower wheel rubbing on blower housing or bad motor bearings.</li> <li>• Popping or squealing sound. Check for a sticky or frayed belt.</li> </ul>

# TROUBLE SHOOTING

## ⚠ WARNING

To avoid risk of electrical shock, personal injury or death; disconnect power to dryer before servicing, unless testing requires power.

## COMPONENT TESTING PROCEDURES

### Component Electrical Testing (with ohmmeter)

- Thermistor resistance 10K  $\Omega$  @ 25°C 77°F
- Thermostat 1 resistance < 1 $\Omega$
- Belt Cut-off S/W
  - Lever open: Resistance value < 1 $\Omega$
  - Lever push: Resistance value :  $\infty$   $\Omega$

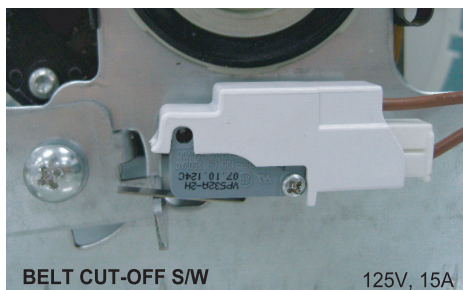
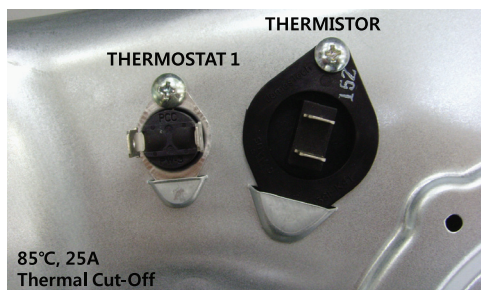

- Thermostat 3 resistance < 1 $\Omega$ 
  - If resistance is infinity, replace thermostat 3.
- Thermostat 2 resistance < 1 $\Omega$ 
  - If resistance is infinity, replace thermostat 2.
- Heater resistance 10  $\Omega$ 
  - If resistance is infinity, replace Heater.

- Lamp resistance 80~100  $\Omega$  (Violet & gray)

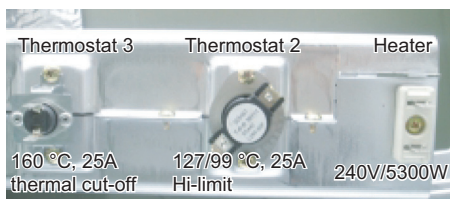
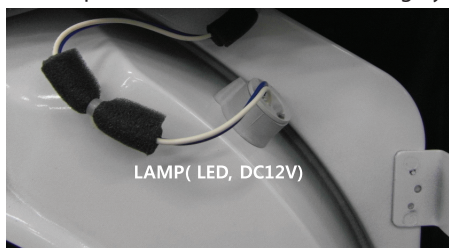

- Motor (Electronic & GAS)

### Contacts

Function	1M	2M	3M	5M	6M
Start			●—●	●—●	
Run	●—●			●—●	●—●

- = Contact closed

## Centrifugal Switch (Motor)

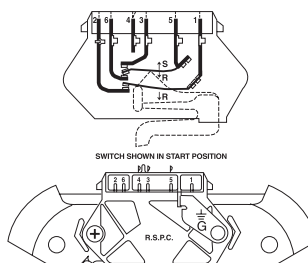

2.88 $\Omega$  between  
Pin# 3 and 4

3.5 $\Omega$  between  
Pin# 4 and 5

- Measure resistance of the following terminal

### 1) Door switch : open

**Terminal : "COM" - "NC" (1-3) < 1 $\Omega$**

**Terminal : "COM" - "NO" (1-2) :  $\infty$   $\Omega$**

### 2) Door switch push: On

**Terminal : "COM" - "NC" (1-3) :  $\infty$   $\Omega$**

**Terminal : "COM" - "NO" (1-2) < 1 $\Omega$**





# TROUBLE SHOOTING

## WARNING

To avoid risk of electrical shock, personal injury or death; disconnect power to dryer before servicing, unless testing requires power.

### GAS MODEL ONLY

#### Radiant Sensor(10RS)

Resistance value  $< 1 \Omega$

If resistance is infinite, replace Radiant sensor

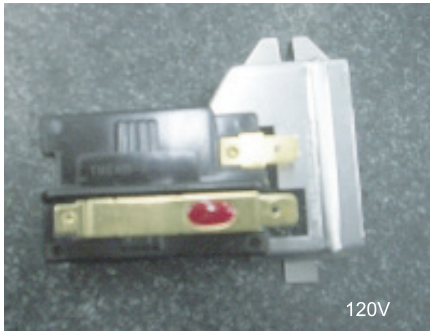

#### Igniter(101D)

Resistance value  $40 \sim 400 \Omega$

If resistance is infinite, replace Igniter

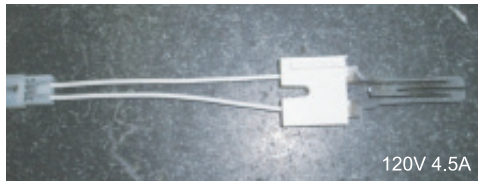

#### Gas Valve(25M01A)

Valve 1-2 : Resistance value  $1.2K \Omega$

Valve 1-3 : Resistance value  $0.5K \Omega$

Valve 4-5 : Resistance value  $1.2K \Omega$

If resistance is infinity, replace Valve

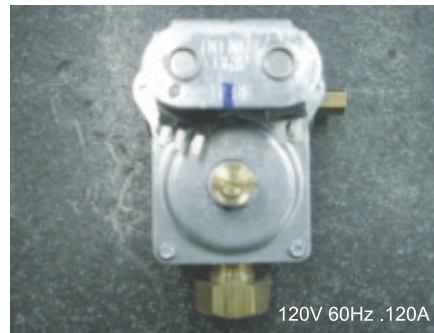

#### Thermostat (60T21 Hi-Limit)230F-50F

Resistance value  $< 1 \Omega$

If resistance is infinity, replace Thermostat



# TROUBLE SHOOTING

## WARNING

To avoid risk of electrical shock, personal injury or death; disconnect power to dryer before servicing, unless testing requires power.

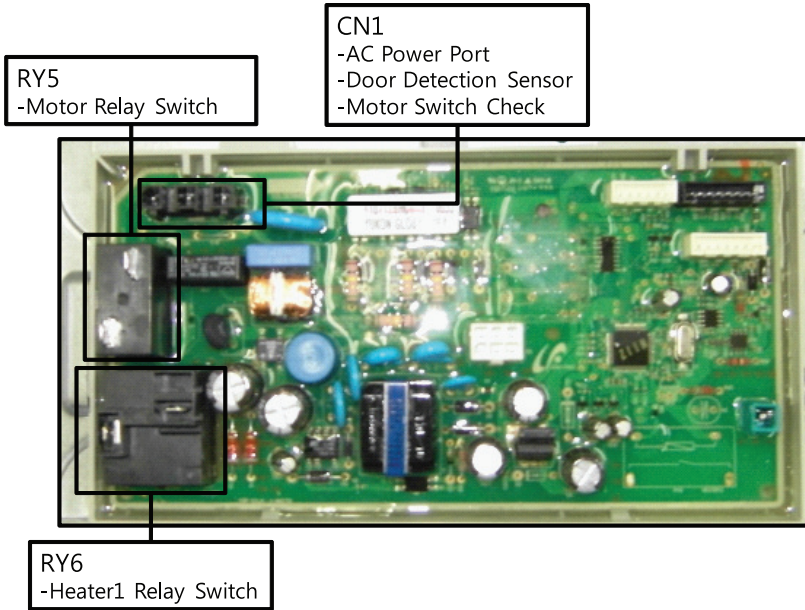

## Sensor Bars & temperature sensor check

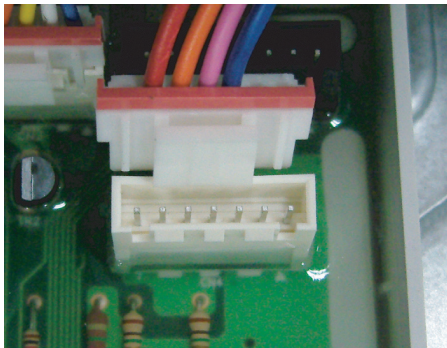

**Sensor Bars** - Disconnect harness and test Pink wire Pin 4 to Orange wire Pin 5.  
Approx  $\infty \Omega$  without laundry  
Approx  $190\Omega \pm 10\%$  with wet clothes

**Cycling Thermistor** - Disconnect harness and test Blue wire Pin 2 to Red wire Pin 6.  
Approx  $10\text{ K}\Omega$  at  $25\text{ }^\circ\text{C}/77\text{ }^\circ\text{F}$

# TROUBLE SHOOTING

## WARNING

To avoid risk of electrical shock, personal injury or death; disconnect power to dryer before servicing, unless testing requires power.

### 3-WIRE system connections

- A.** External ground connector
- B.** Neutral grounding wire (green/yellow)
- C.** Center silver-colored terminal block screw
- D.** Earth wire
- E.** strain relief

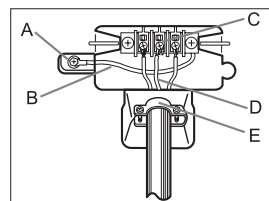

1. Loosen or remove the center terminal block screw.
2. Connect the earth wire (white or center wire) of the power cord to the center, silver-colored terminal screw of the terminal block. Tighten screw.
3. Connect the other wires to outer terminal block screws. Tighten screws.
4. Tighten the strain relief screws.
5. Insert the tab of the terminal block cover into your Dryer's rear panel slot. Secure the cover with a hold-down screw.

If converting from a 4-wire electrical system to a 3-wire, the ground strap must be reconnected to the terminal block support to ground the Dryer frame to the neutral conductor.

### 4-WIRE system connections

- A.** External ground connector
- B.** Green or bare copper wire of power cord
- C.** strain relief
- D.** Center silver-colored terminal block screw
- E.** Neutral Grounding wire (green/yellow)
- F.** Neutral wire (white or center wire)

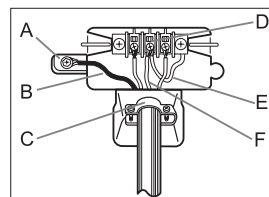

1. Remove the External ground connector screw.
2. Connect the ground wire (green or unwrapped) of the power cord to the external ground connector screw. If you want to connect B(Green or bare copper wire of power cord) to the Neutral Post without assembling with A(cabinet ground), call the service technician.
3. Loosen or remove the center terminal block screw.
4. Connect the neutral wire (white or center wire) of the power cord and the appliance ground wire (green with yellow stripes) under the central screw of the terminal block.
5. Connect the other wires to the outer terminal block screws. Tighten screws.
6. Tighten the strain relief screws.
7. Insert the tab of the terminal block cover into your Dryer's rear panel slot. Secure the cover with a hold-down screw.

# WIRING DIAGRAM

## **⚠ WARNING**

To avoid risk of electrical shock, personal injury or death; disconnect power to dryer before servicing, unless testing requires power.

## WIRING DIAGRAM

